

Next

A product by
Rancilio Group

NEXT

YOUR NEXT
COFFEE
IS NOT
THAT FAR



ENGLISH



YOUR NEXT COFFEE IS NOT THAT FAR.

Egro Next is the new frontier in fully automatic coffee machines. Featuring stylish ergonomic design, Egro Next is intuitive, easy to use and to clean. It guarantees top-quality results for all types of coffee, milk and powder-based drinks. Recommended for locations with an average daily consumption of 250 coffee cups, Egro Next has been designed mainly for use in hotels, offices, fast-food restaurants, convenience stores, service stations, cafés and self-service facilities, and is available in 3 versions: Pure Coffee, Quick Milk, and Top Milk.

RECOMMENDED DAILY OUTPUT:

PURE COFFEE
& QUICK MILK:

x250

CUPS PER DAY

TOP MILK:

x300

CUPS PER DAY



HIGHLIGHTS



1

COFFEE

Swiss Coffee Technology

Top-quality results at every cup, thanks to a stainless steel brewing group equipped with Self-Adjusting Grinder technology and separate boilers for coffee and steam.

2

MILK

NMS+

Top-quality milk foam every time, with great consistency, personalised for all beverages, even during the busiest work hours.

3

INTERFACE

10" HD Touchscreen

Swipe, tap and scroll with ease through the menu. It's as easy as using your smartphone, with all preferences and drink selections at your fingertips.

Easy Switch

Customise different menus and easily switch between self-service mode for breakfast and barista mode for lunch or dinner selections at your fingertips.

4

DESIGN

Built to last

Stainless steel brewing group and high-value components come together in a robust design for high performance and maximum durability.

5

ADD-ONS

Total flexibility for every business

Modular portfolio, flexibility, add-ons, fridges, optional features and payment systems to create a bespoke setup for every instance.

6

CLEANING

Easy to clean

Daily cleaning program and rinsing cycles.

SWISS COFFEE TECHNOLOGY



STAINLESS STEEL BREWING UNIT

The stainless steel brewing unit is available in two brewing chambers with different capacities, either 18 g or 22 g. (optional). The latter version allows you to prepare extra-large American coffees in a single brewing cycle.

STAINLESS STEEL FLAT BURRS

High-precision grinders are equipped with titanium coated stainless steel burrs to provide consistent coarseness for top-quality espresso brewing.

54mm

BURRS DIAMETER

DUAL BOILER TECHNOLOGY

Two separate boilers for coffee preparation and steam.

0.5 l /16.9 oz.

COFFEE BOILER CAPACITY

1.9 l /64.2 oz.

STEAM BOILER CAPACITY

E SELF-ADJUSTING GRINDER

The Self-Adjusting Grinder (SAG) can correct any in-cup quality alterations in real time, ensuring coffee consistency in every cup.

1 kg/2.2 lb

BEAN HOPPER CAPACITY

● Egro Patented Technology

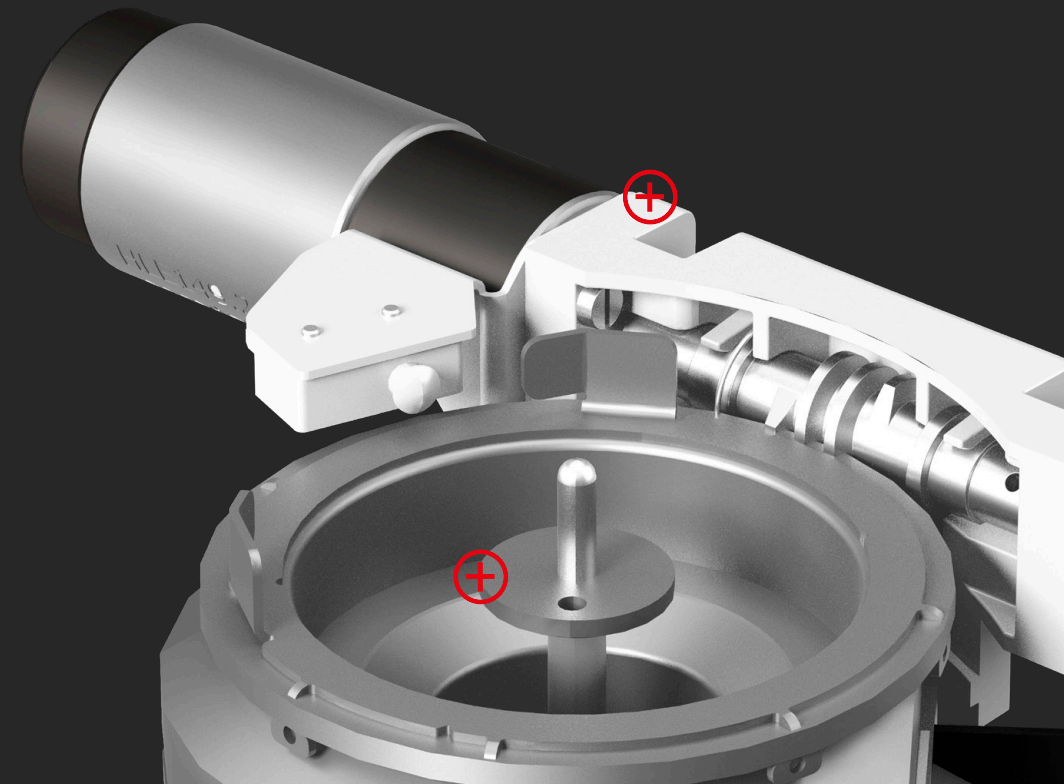

MILK, WATER & STEAM



+ MILK

NMS+

Always ensure the right temperature and milk frothing level for each beverage.

COLD MILK FOAM

The Cold Milk Foam (CMF) system allows you to automatically prepare the perfect cold milk foam for all recipes and easily select between 3 different types of foam via touchscreen.

+ WATER

X-TEA

X-TEA provides different programmable water temperature levels and dosages for tea and other herbal infusions.

WATER WAND

The separate water wand is extendable to suit all the operator's needs and it is possible to deliver water while brewing coffee.

+ STEAM

iSTEAM

iSteam communicates with the touchscreen interface to automatically prepare the milk at the right temperature and froth level mixing steam.

COOL TOUCH STEAM WAND

The cool touch steam wand can be handled in safety and comfort.

SMART INTERFACE

TOUCHSCREEN INTERFACE

Access, select and adjust settings as easily as you do on your smartphone, thanks to the intuitive 10.1" HD touchscreen interface.

x10

MENU AVAILABLE
IN 10 LANGUAGES

MULTI-DRINK

Rely on the step-by-step instructions provided by the Multi-Drink software to easily create any recipe you wish in just a few taps. Select your favourite blend or single origin, choose the desired coffee strength, set the pre-infusion time, add the preferred milk or powders.

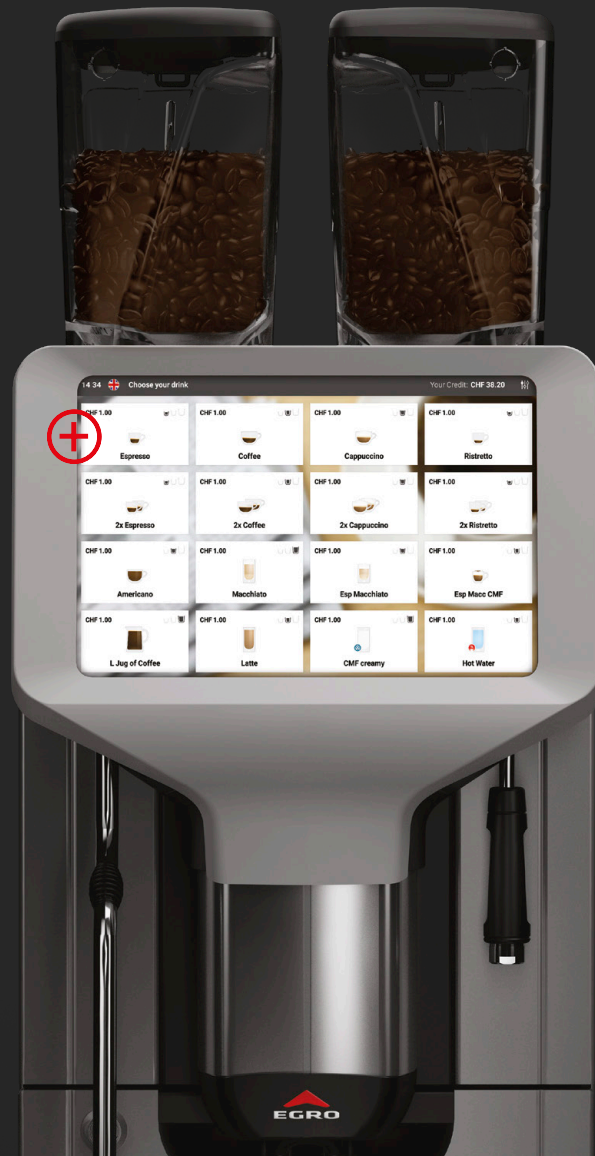

EASY SWITCH

Customise different menus and quickly switch between them to always have the perfect settings for any situation.

THREE ACCESS LEVELS

Egro Next has three dedicated menus to offer the best user experience to baristas, managers and technicians.

QUEUE MODE

The selected items are placed in a queue, possibility for any drink to be brewed earlier or later, to be cancelled or others added.

COUNTERS

Counters are available to display the number of brewed drinks, the income generated, SAG statistics and cleaning settings.

MULTIMEDIA

Images or promotional videos can be uploaded and showcased during brewing.

iBUTTON

iButton gives extra information on the product selected as the nutritional value and the origin of its ingredients.

SELF-SERVICE MODE

Customers can prepare one drink at a time on their own, without the support of the staff.

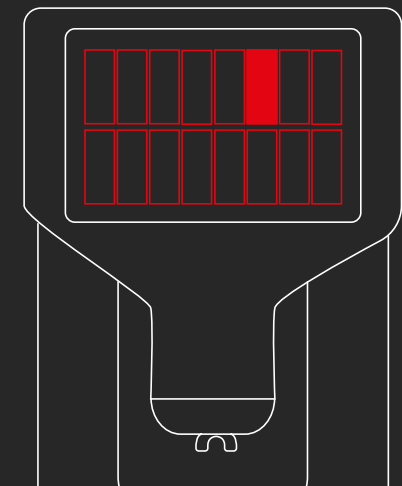

DESIGN & ERGONOMICS



With its polished stainless steel finish, Egro Next is a stylish, ergonomic, and highly functional machine, with clean, soft lines and scratch-resistant surfaces. The aluminium display frame matches the modern look of the machine.

SPACE-SAVING DESIGN

30cm / 12in

MAIN UNIT WIDTH

LED LIGHTS

Maximum visual comfort thanks to LED lights on the work area.



STAINLESS STEEL TRAY

The stainless steel tray is easy to remove and clean. In the self-service version it has two different cup-placing positions, to ensure that any type of cup is always placed correctly under the brewing spout.

AUTOMATIC SPOUT

The Automatic Spout adjusts the height of the brewing spouts to suit the drink selected and fit the type of cup being used. The spout is easy to remove for cleaning.

ADD-ONS

BENEFITS

Boost the potential of your Egro Next with optional features that expand your options and make managing the machine even easier.

x8

ADD-ON OPTIONS



EGRO NEXT TOP MILK

+ NEXT FRIDGE
+ POWDER MODULE
+ CUP WARMER

NEXT FRIDGE

Take milk to the next level with the most advanced 6.5 lt fridge, featuring level control and the option to use different types of milk.

QUICK MILK FRIDGE

Stylish, practical 4-litre Quick Milk Fridge with a brushed stainless steel door.

FUM FRIDGE

The FUM 4-litre fridge can be placed right below the machine for best space optimization.

E SMPU

For external refrigeration units placed under the counter, Egro Next can be equipped with a milk pump unit with a pressure sensor to control milk fill level.

GUM

External box for waste coffee.

POWDER MODULE

Offer customers new options by setting up an external Powder Module: select ingredients to automatically mix, prepare and dispense.

2x 1 kg/2.2 lb

POWDER HOPPERS CAPACITY

TEA BREWER

Have the delicious comfort of traditional tea with the efficiency of our professional coffee machines, with the Tea Brewer module. The ideal solution for preparing also Thai tea and many more recipes.

CUP WARMER

External cup warmer with adjustable temperature level and three heatable trays.

PAYMENT SYSTEMS

Enjoy utmost flexibility with a range of standard and optional payment system solutions.

● Egro Patented Technology

MAXIMUM FLEXIBILITY

A WIDE RANGE OF SETUPS

Egro designs personalised solutions for all needs.

+ SOME SETUPS

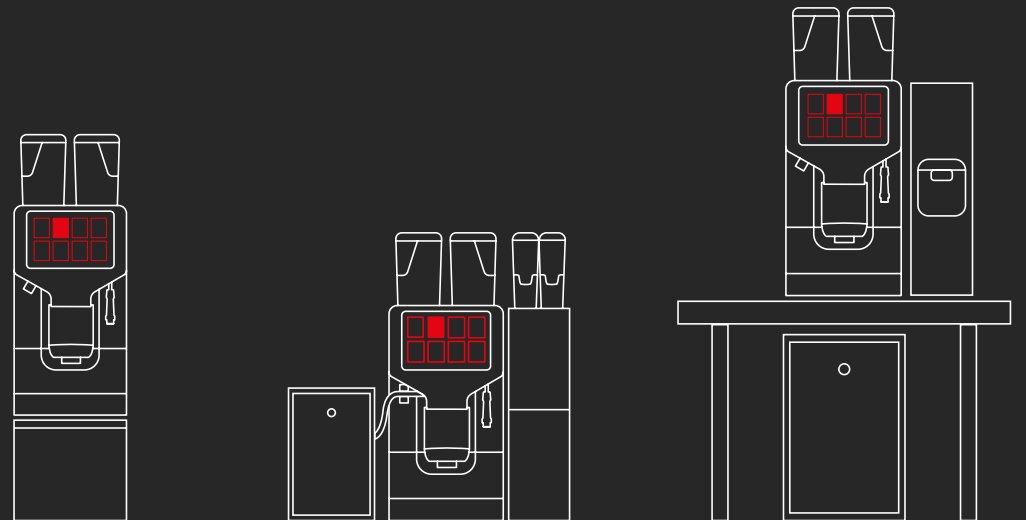
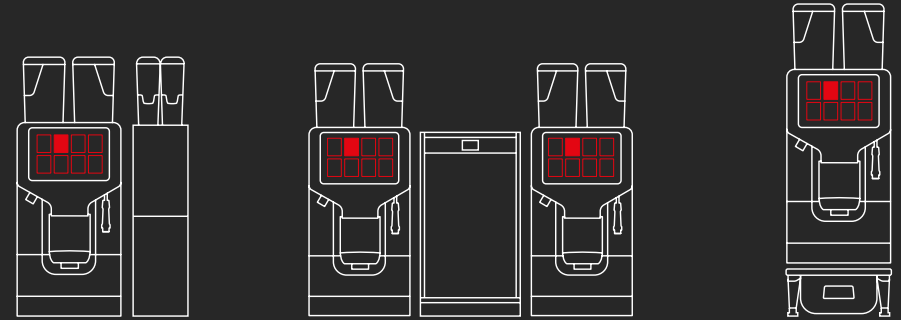
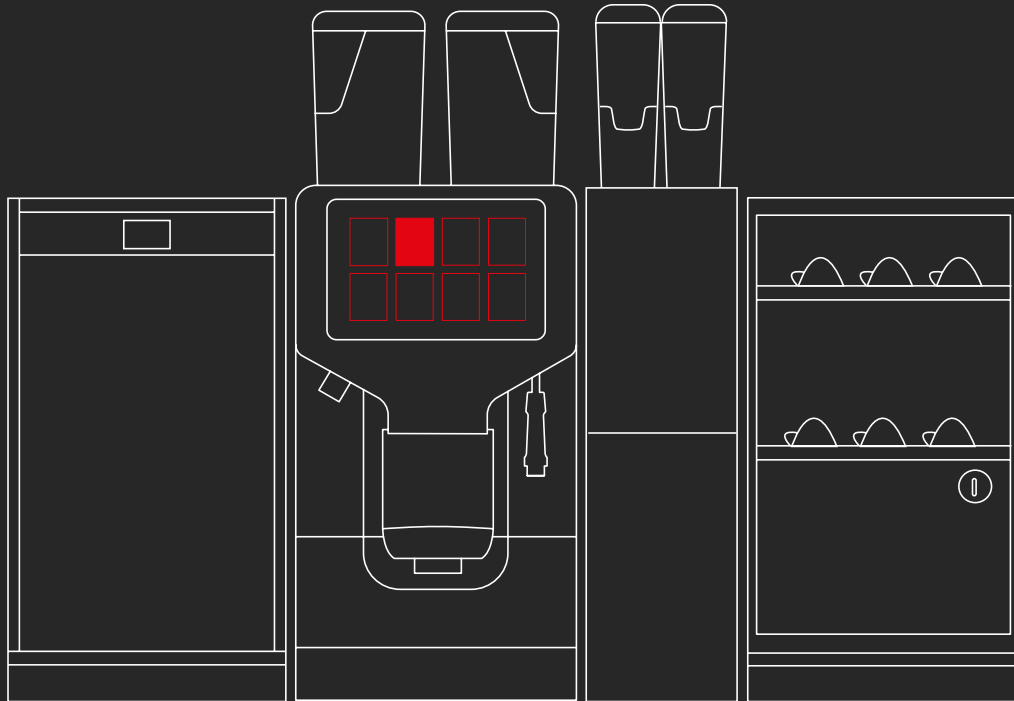

EGRO NEXT TOP MILK

- + NEXT FRIDGE
- + POWDER MODULE
- + CUP WARMER

CLEANING & MAINTENANCE



CLEANING

Fast and simple cleaning makes it easy to uphold high health and hygiene standards.



E MILK LINE RINSING

A standard feature of the Next Top Milk is cold rinsing of the milk circuit, followed by a blow out with air.

EASY ACCESS TO ALL COMPONENTS

The convenient opening of the front panel and quick access to the main internal components facilitates easy maintenance operations.

RINSING CYCLE

A rinsing cycle starts automatically at a preset time after the last beverage delivery.

E DURA BREW

Dura Brew is a hermetically sealed system requiring little maintenance, and thus reducing the total cost of ownership.

USB PORT

Next comes with a USB port to transfer technical data and upload images and videos.

CONNECT

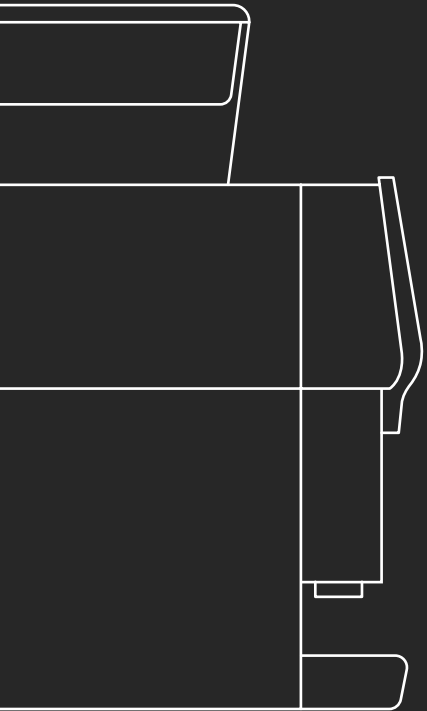

TELEMETRY SYSTEM

Connect: a remote telemetry system to adjust all the parameters, check statistics and ensure optimal functionality.

TIME TO CONNECT

Connect is a remote telemetry system to monitor all the operations performed by a single coffee machine or by a whole set of machines. Thanks to Connect, you can adjust the settings for coffee delivery, analyse consumption statistics and read any messages related to technical assistance and maintenance.

BENEFITS



1

JUST-IN TIME CONTROL



2

REDUCED SERVICE COSTS



3

SALES OPTIMISATION



4

PREDICTIVE MAINTENANCE



5

CLOUD ENVIRONMENT



6

ALERTS



7

ALWAYS CONNECTED



8

CONSUMPTION STATISTICS

NEXT: TECHNICAL SPECIFICATIONS

DIMENSIONS

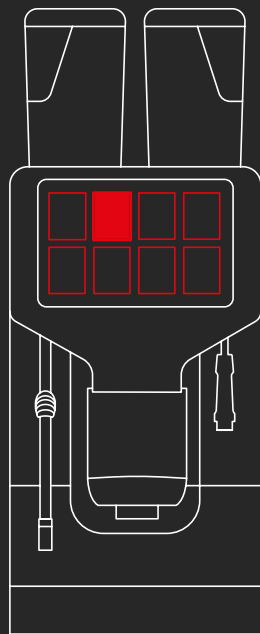

770 mm / 30.3 inch

300 mm / 11.8 inch

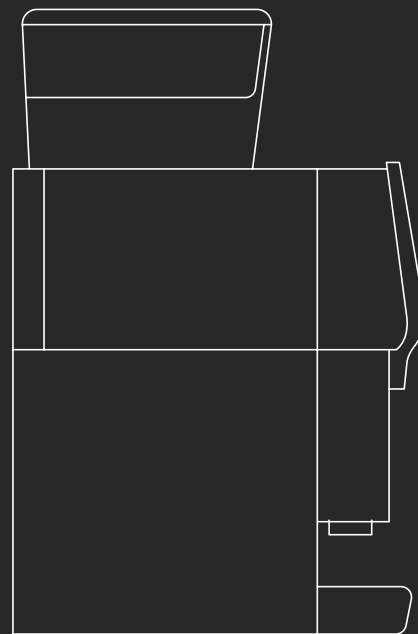

575 mm / 22.6 inch

PERFORMANCE	RECOMMENDED DAILY OUTPUT Pure Coffee, Quick Milk: 250 Cups Top Milk: 300 Cups NOISE LEVEL DURING USE <70 db	
OPERATING PANEL	INTERFACE Touchscreen LANGUAGES AVAILABLE 10	NUMBER OF BEVERAGES PER PAGE 16
COFFEE	GRINDER Self-Adjusting Grinder (SAG) BREWING CHAMBER 18 gr COFFEE BEAN HOPPER CAPACITY 1 kg / 2.2 lb each	
WATER	DELIVERY Central hot water output	
DIMENSIONS MAIN UNIT	W × D × H 300 × 575 × 770 mm 11.8 × 22.6 × 30.3 in	WEIGHT 57 kg / 125.7 lb
POWER	TOTAL POWER 3.6 kW - 6 kW FREQUENCY 50-60 Hz	VOLTAGE 1N 220-240V / 2N 380-415V
BOILER	COFFEE BOILER 0.5 l / 16.9 oz.	STEAM BOILER 1.9 l / 64.2 oz.
OPTIONAL	+ 2nd grinder (SAG) + Bypass single cup + Bypass dual cup + Automatic Spout (only on Pure Coffee and Top Milk) + 22-gr brewing chamber (BC22) + Under counter grounds chute + Right side hot water outlet + Cool touch steam wand + iSteam + Lock package + Cup stopper	

NEXT: TECHNICAL SPECIFICATIONS

NEXT TOP MILK

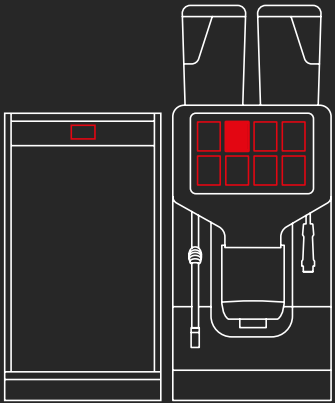

ADD-ONS
AVAILABLE:

- + NEXT FRIDGE
- + POWDER MODULE
- + CUP WARMER
- + TEA BREWER
- + GUM
- + FUM FRIDGE
- + PAYMENT SYSTEM

NEXT PURE COFFEE

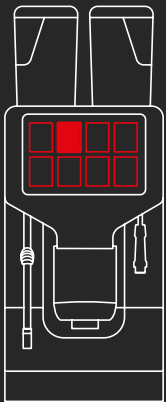

ADD-ONS
AVAILABLE:

- + POWDER MODULE
- + CUP WARMER
- + TEA BREWER
- + GUM
- + PAYMENT SYSTEM

NEXT QUICK MILK

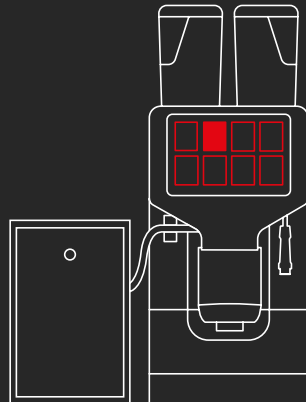

ADD-ONS
AVAILABLE:

- + QUICK MILK
FRIDGE
- + POWDER MODULE
- + CUP WARMER
- + TEA BREWER
- + GUM
- + FUM FRIDGE
- + PAYMENT SYSTEM

DELIVERY CAPACITY	PURE COFFEE	QUICK MILK	TOP MILK
	1X • 2X	1X • 2X	1X • 2X
ESPRESSO cups / hour	125 • 205	125 • 205	125 • 205
CAPPUCCINO cups / hour		120 • 160	129 • 207
CAFE CREME cups / hour	109 • 140	109 • 140	109 • 140
HOT WATER cups / hour	186	186	186
RECOMMENDED DAILY OUTPUT cups	200	200	250
ENERGY LOSS PER DAY kWh	1,772	1,772	1,873

BEVERAGES	PURE COFFEE	QUICK MILK	TOP MILK
ESPRESSO	+	+	+
AMERICANO	+	+	+
CAPPUCCINO		+	+
LATTE MACCHIATO		+	+
HOT MILK		+	+
HOT MILK FOAM		+	+
COLD MILK		+	+
COLD MILK FOAM			+
CHOCOLATE AND OTHER POWDERS	+	+	+
TEA	+	+	+
HOT WATER	+	+	+

ADD-ONS: TECHNICAL SPECIFICATIONS

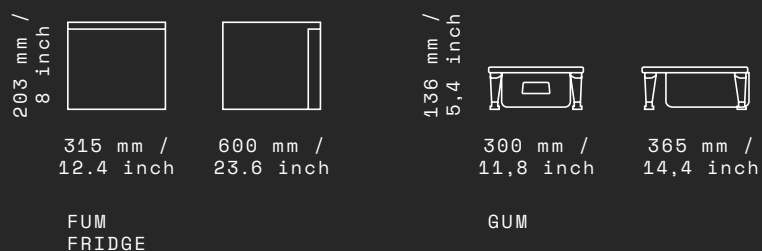
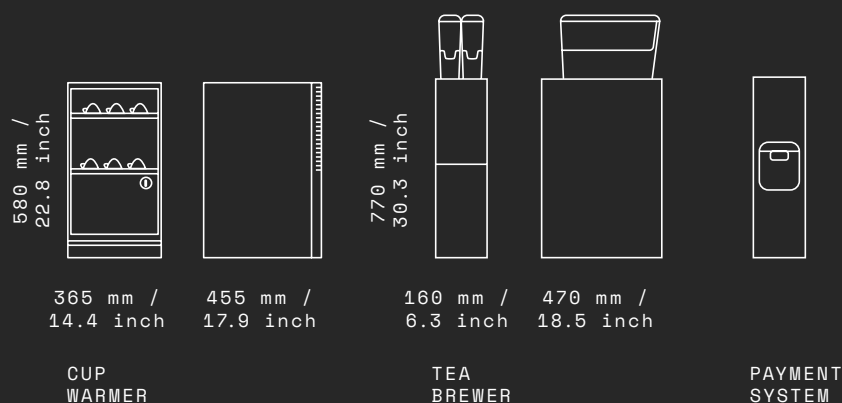
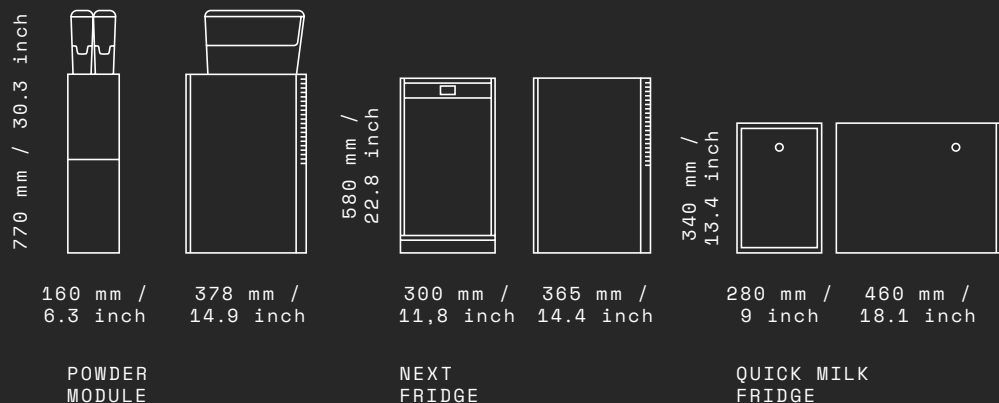

POWDER MODULE

W × D × H
160 × 378 × 770 mm
6.3 × 14.9 × 30.3 in

WEIGHT
13 kg / 28.1lb

POWER
0.10 kW

VOLTAGE
220-240V 50/60Hz /
120V 60Hz

CUP WARMER

W × D × H
365 × 455 × 580 mm
14.4 × 17.9 × 22.8 in

WEIGHT
14 kg / 30.1lb

POWER
0.42 kW

VOLTAGE
220-240V 50/60Hz

NEXT FRIDGE

W × D × H
300 × 365 × 580 mm
11.8 × 14.4 × 22.8 in

WEIGHT
29 kg / 63.9 lb

POWER
0.10 kW

CAPACITY
6.5 l

VOLTAGE
220-240V 50/60Hz /
120V 60Hz

FUM FRIDGE

W × D × H
315 × 600 × 203 mm
12.4 × 23.6 × 8 in

WEIGHT
18.5 kg / 40.8 lb

POWER
0.08 kW

CAPACITY
4 l

VOLTAGE
220-240V 50/60Hz /
1N ~115V 60Hz

QUICK MILK FRIDGE

W × D × H
230 × 460 × 340 mm
9 × 18.1 × 13.4 in

WEIGHT
14 kg / 30.1lb

POWER
0.10 kW

CAPACITY
4 l

VOLTAGE
220-240V 50/60Hz /
1N ~120V 60Hz

TEA BREWER

W × D × H
160 × 470 × 770 mm
6.3 × 18.5 × 30.3 in

WEIGHT
18 kg / 39.7lb

VOLTAGE
24V

GUM

W × D × H
300 × 365 × 136 mm
11.8 × 14.4 × 5.4 in

VOLTAGE
24V

CAPACITY
750 g / 1.6 lb

OTHER + PAYMENT SYSTEM

 **RANCILIO** GROUP

rancioliogroup.com



an Ali Group company



The Spirit of Excellence