



A GREEN ATTITUDE
SUSTAINABILITY TO
RANCILIO GROUP

MISSION

OUR VALUES

IMPACT AREAS

1. ENVIRONMENT

(EMBRACING
CIRCULAR
ECONOMY)

2. PEOPLE

(OVERVIEW)
(HEALTH)
(EDUCATION)
(COMPANY IDENTITY)

3. GOVERNANCE

(PROCEDURES)
(PRODUCT)
(TECHNOLOGIES)
(DIGITALIZATION)

MISSION

For Rancilio Group, sustainability is a responsibility which involves each and every part of our business worldwide. As a cornerstone of our vision, it will be a crucial factor in the process as we define a new development model capable of balancing economic, financial, environmental and social interests.

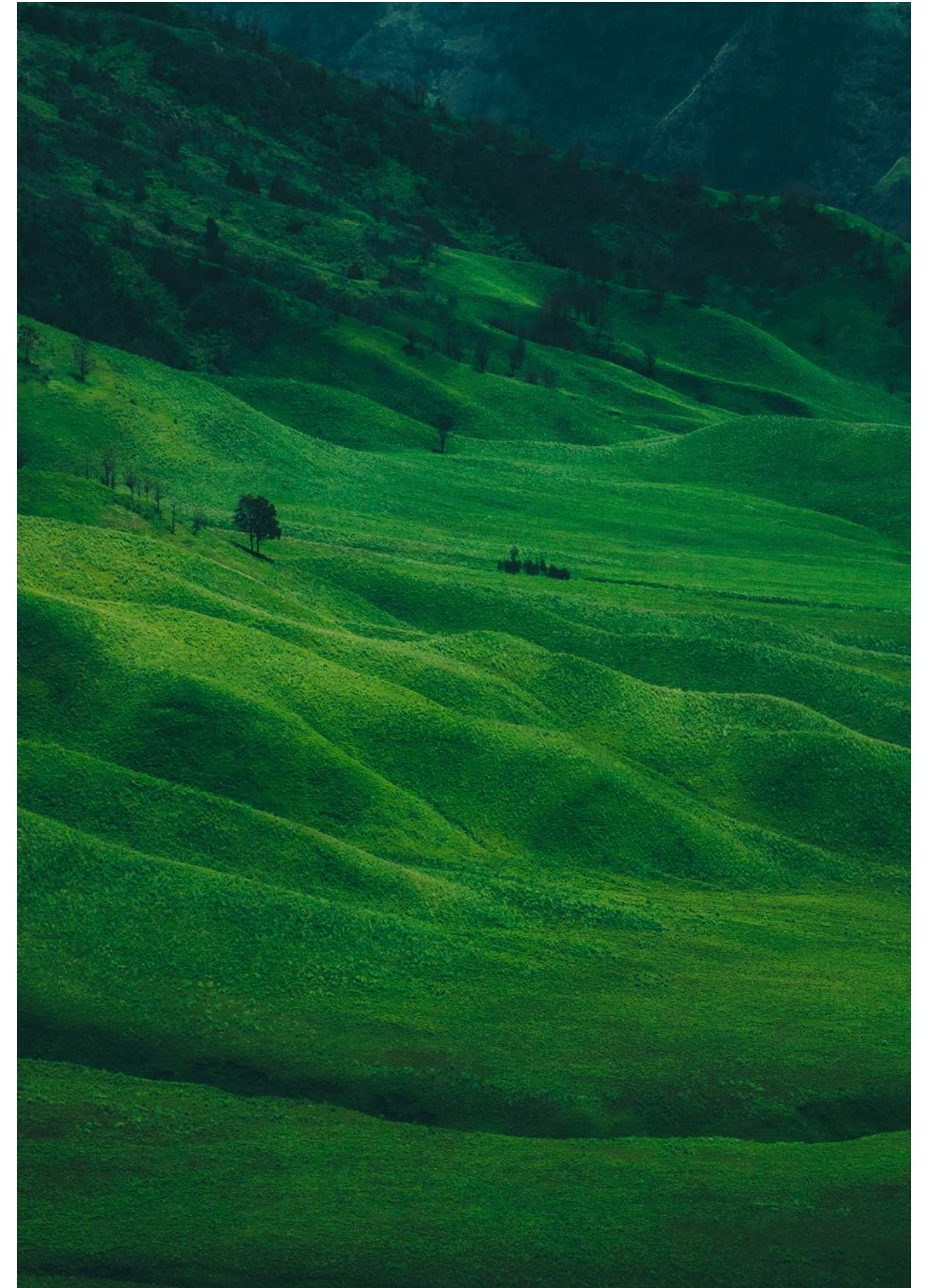

OUR VALUES

EXCELLENCE AT YOUR SERVICE

Welcome to our Code of Conduct, which summarises the style of our company and the values that represent everything we stand for and believe in. Our company has grown over time, while remaining faithful to ourselves and our personnel. This heritage should be preserved, protected, and developed.



ETHICS is the key value that represents us. We conduct our business with the utmost respect for our customers, our personnel, and the context in which we work.

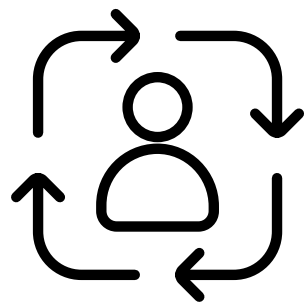

CUSTOMER CENTRICITY is our approach.

We are curious and open to working with customers and partners to find the best answers to their needs, placing all our unique expertise at their service.

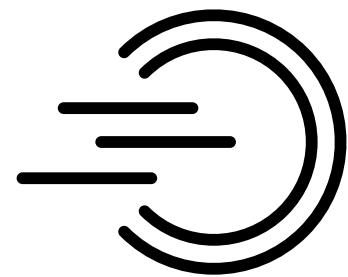

AGILITY is an essential value. We work as a team to be flexible in providing quick, useful answers.

We develop solutions quickly, while upholding our responsibilities. We have the courage to take the initiative intelligently.

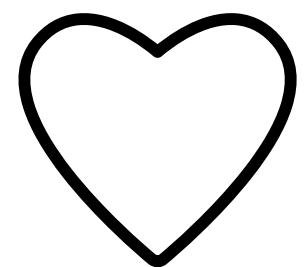

PASSION is what drives us. We are passionate about innovations that enhance the coffee experience, stimulating customers to design a future of state-of-the-art products and solutions with regard to appearance and functionality. We act as consultants, working with our customers to find innovative solutions together.

N.B: The Code of Ethics and the Integrated Policy are available for consultation on the [Rancilio Group website](#).

IMPACT AREAS

1. ENVIRONMENT

EMBRACING CIRCULAR ECONOMY

Rancilio Group recognizes the impact which global businesses like ours have on the environment and society, and for this reason we take responsibility in our daily economic activities and commit to address the climate change crisis by taking the first crucial steps to embracing and promoting the principle of **circular economy**.

We are involving all our stakeholders in our plan towards sustainability and working to create innovative solutions throughout our value chain.

In order to do so, we have started to follow the 3 principles of sustainability: reducing waste and greenhouse gas emissions, reuse materials and recycle resources.

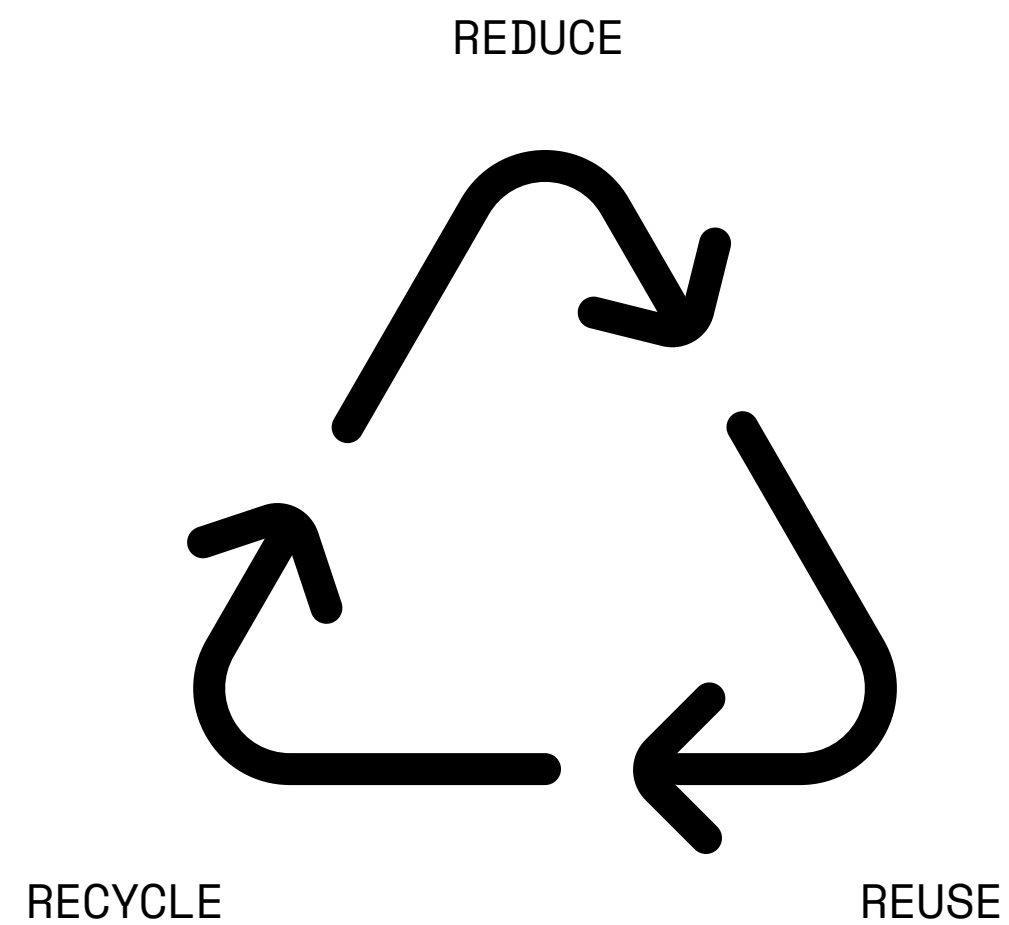

REDUCE EMISSIONS

70%

SOLAR POWER

7%

WIND POWER

10%

HYDROELECTRIC
POWER

13%

OTHER RENEWABLE
ENERGY SOURCES

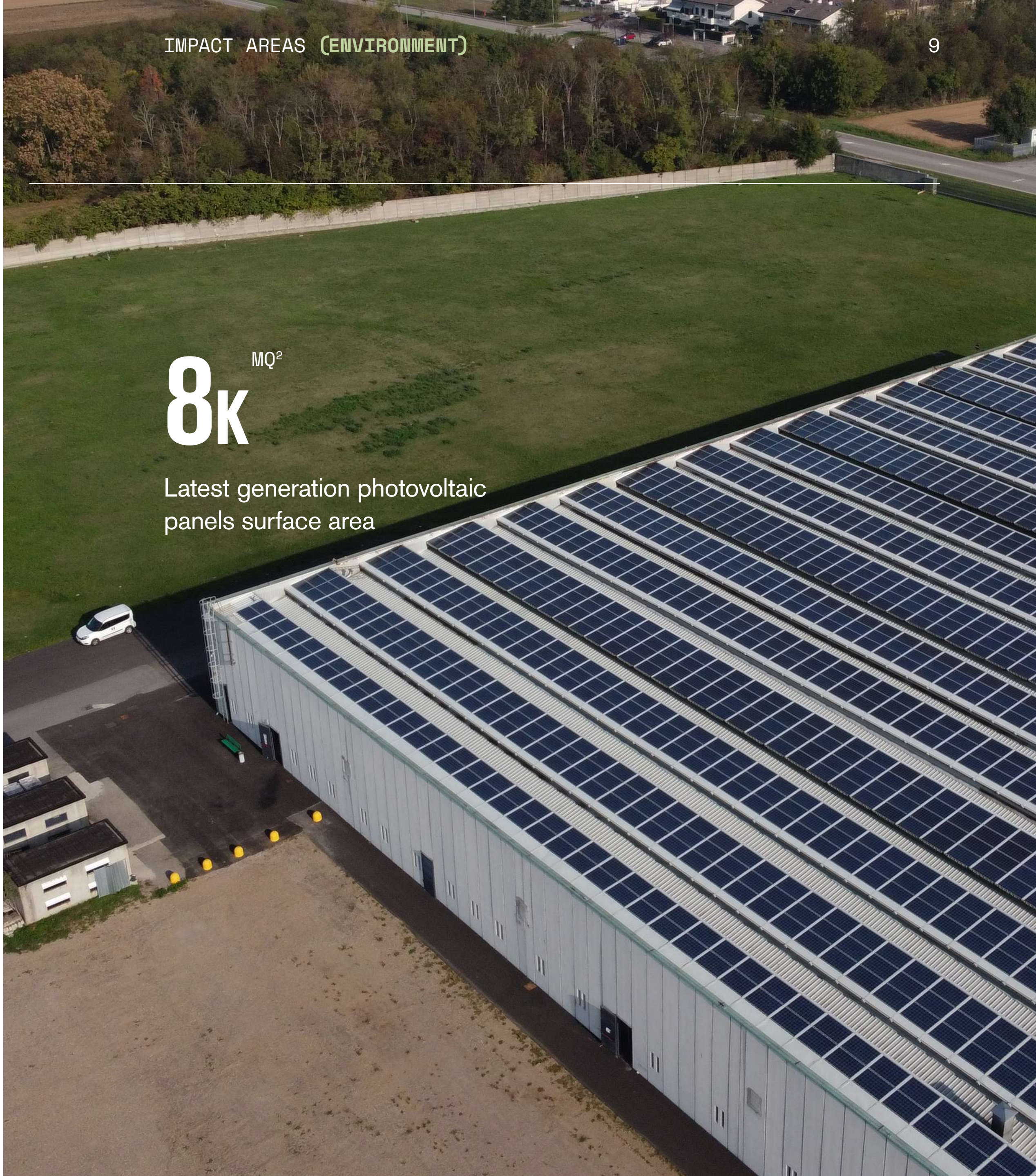

8k ^{MQ²}

Latest generation photovoltaic
panels surface area

REDUCE EMISSIONS

**FROM 2020 RANCILIO GROUP
HEADQUARTERS ARE POWERED
BY 100% ENERGY FROM
RENEWABLE SOURCES**

REDUCE EMISSIONS

In 2023, Rancilio Group launched a relamping project, a transformational initiative aimed at replacing our production plant's lighting system with energy-efficient LED technology.

- Up to 90% less energy consumption
- Enhanced illumination and extended lifespan
- Minimize waste and environmental impact

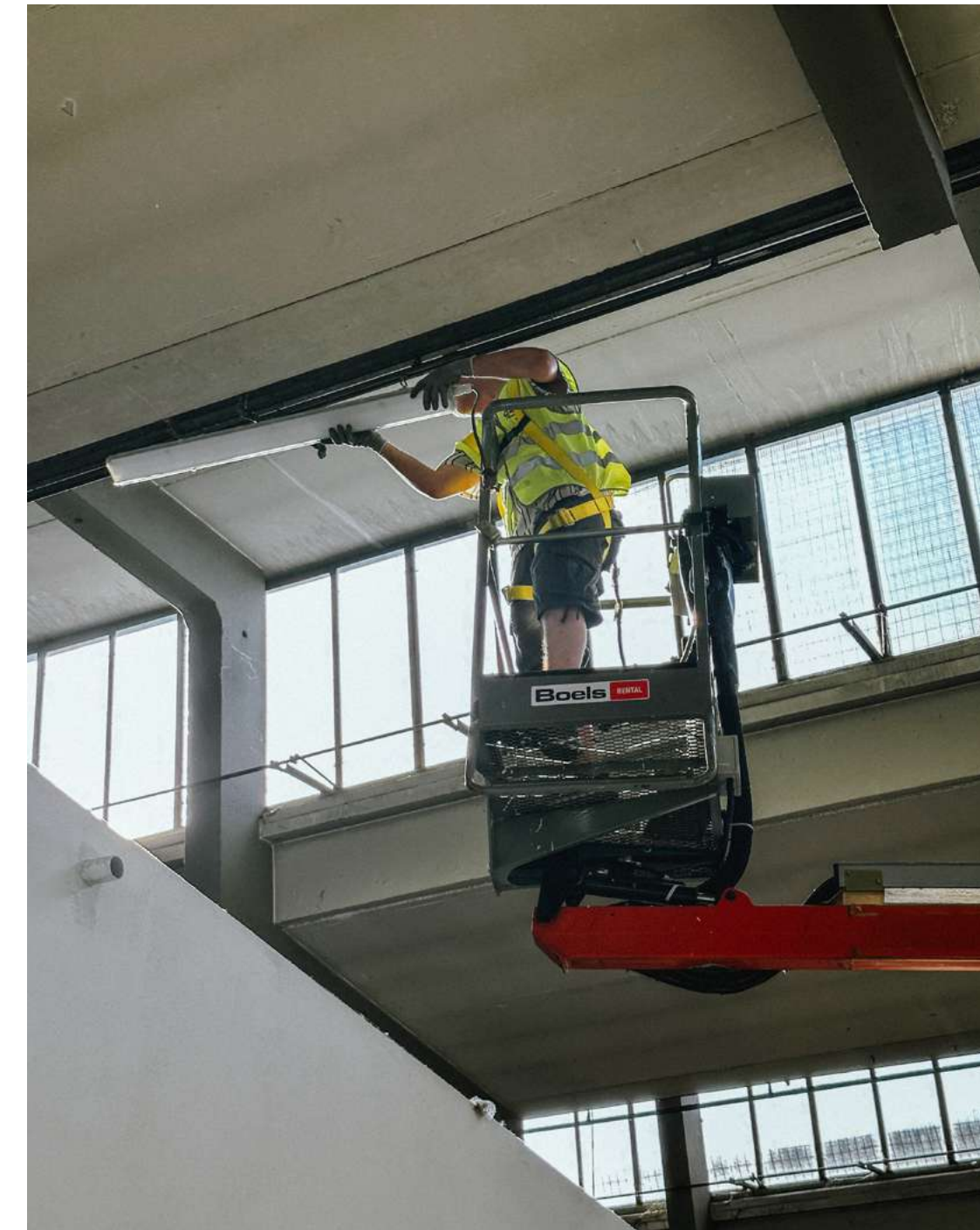
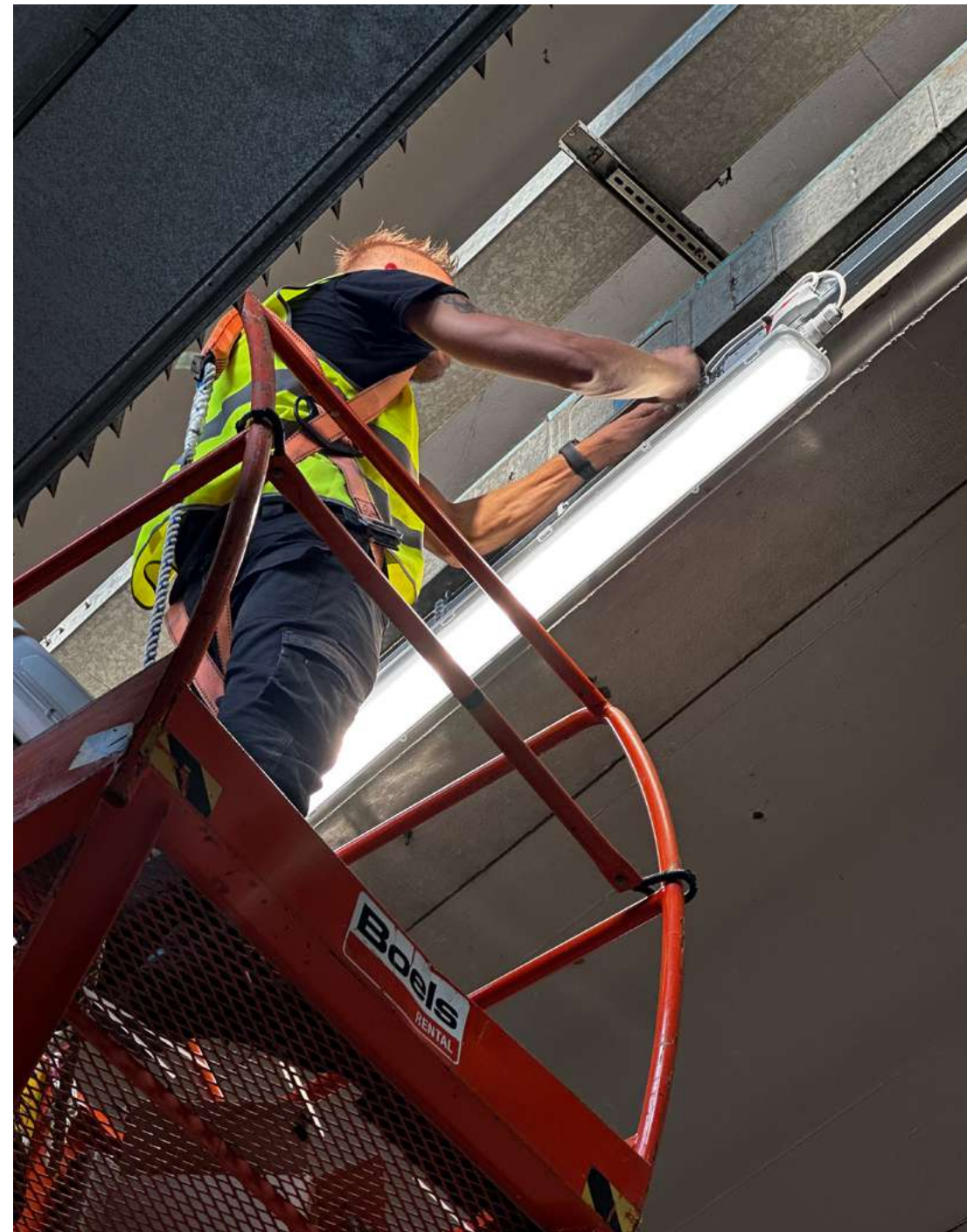

RECHARGE WITH 100% GREEN ENERGY

From 2022 Rancilio Group offers modern charging stations for electric vehicles. Now 25% of our company cars are electric and we aim at increasing this value gradually in the next few years.



SMART WORKING TO REDUCE CO₂ EMISSIONS

Starting from 2020 Rancilio Group sets individual smart working contracts for our office team to benefit from a better work-life balance, and to contribute to limiting our weekly CO₂ emissions.



REUSE & RECYCLE

100%

USE OF BIODEGRADABLE
OILS AND PRODUCTS

100%

REUSABLE CLOTHS
to remove any residual grease and
dust from finished products during
cleaning.

Iron, copper, brass, aluminium, plastic, paper and cardboard

WASTE SEPARATE
COLLECTION

RECYCLE OUR GARDEN

After testing our machines, more than 1000 kg of coffee grounds are used as natural fertiliser in the Company Garden.

Coffee grounds are an excellent natural fertiliser. They contain essential nutrients for plant growth such as nitrogen, phosphorus, potassium and magnesium.

This green corner grows with us and, thanks to the time we spend taking care of it, it gives us back seasonal fruit and vegetables every day.

Furthermore, thanks to this garden, we support the concept of CIRCULAR ECONOMY and, as in ecosystems where nutrients are efficiently utilised and then returned to the cycle, we are able to significantly reduce waste disposal costs.



1000KG

OF COFFEE GROUNDS PER YEAR

EXTENDING EOL

EOL stands for **End of Life** and it refers to the phase in which the product in question has reached the end of its useful life as a product.

Rancilio Group has developed a series of **EOL guidelines** to help our consumers dispose of their product responsibly.

We do also believe that educate our customers to take care of their machine properly can contribute considerably to the extension of a product lifecycle.



EXTENDING EOL (GUIDELINES)

- Carry out **routine maintenance** according to product instructions.
- Use **professional water filtration systems**. Water quality can be of great impact on a product life span.
- All our customers can access our online **spare parts portal** to find the right part for their machine and to avoid early disposal.
- When it is time to dispose of the product, our **product disposal guidelines** can help customers handle waste separate collection correctly.

A FURTHER NOTE ON THE DISMANTLING OF OUR PRODUCTS

A coffee machine is a highly recyclable product, due to its high metal content. Moreover, as professional equipment, it is periodically overhauled with thorough technical inspections and the replacement or repair of parts and components.

The 2012 European Directive regarding Waste from Electrical and Electronic Equipment (WEEE) requires manufacturers of electrical and electronic equipment to ensure the recovery, the recycling and the disposal of products at the end of their lifecycle in Europe.

Rancilio Group pays a contribution to Erion WEEE, a non-profit Collective Scheme dedicated to the collection of Household and Professional WEEE at national level, including coffee equipment, and its transport to specialised plants for recycle, energy recovery, and disposal according to the highest environmental standards.

2. PEOPLE

CREATING VALUE

We are committed to contribute to our team life quality and development in three important areas: health, education and company identity.

This includes to look over their physical and mental well-being, their personal and professional growth, and to help build their strength and identity as part of a large, heterogeneous team.



OVERVIEW

335

EMPLOYEES IN
7 COUNTRIES

8

BRANCHES
In Switzerland, Germany, Spain,
Portugal, China, Australia, USA and UK

2

SALES REPRESENTATIVES
In Japan and Russia

22%

WOMEN EMPLOYMENT

43yo

EMPLOYEES'
AVERAGE AGE

8.5y

EMPLOYEES'
AVERAGE TENURE

99%

PERMANENT
CONTRACTS

FAIR REMUNERATION

Rancilio Group commits to pay all our collaborators a fair salary to guarantee more security, domestic stability and respect for human rights, including the right to development, in accordance with the National Collective Labor Agreement (CCNL) for the metalworking sector.

WE ARE COMMITTED TO CONTRIBUTE TO OUR TEAM LIFE QUALITY AND DEVELOPMENT IN THESE 3 DISTINCT AREAS

1. HEALTH

For their physical and mental well-being

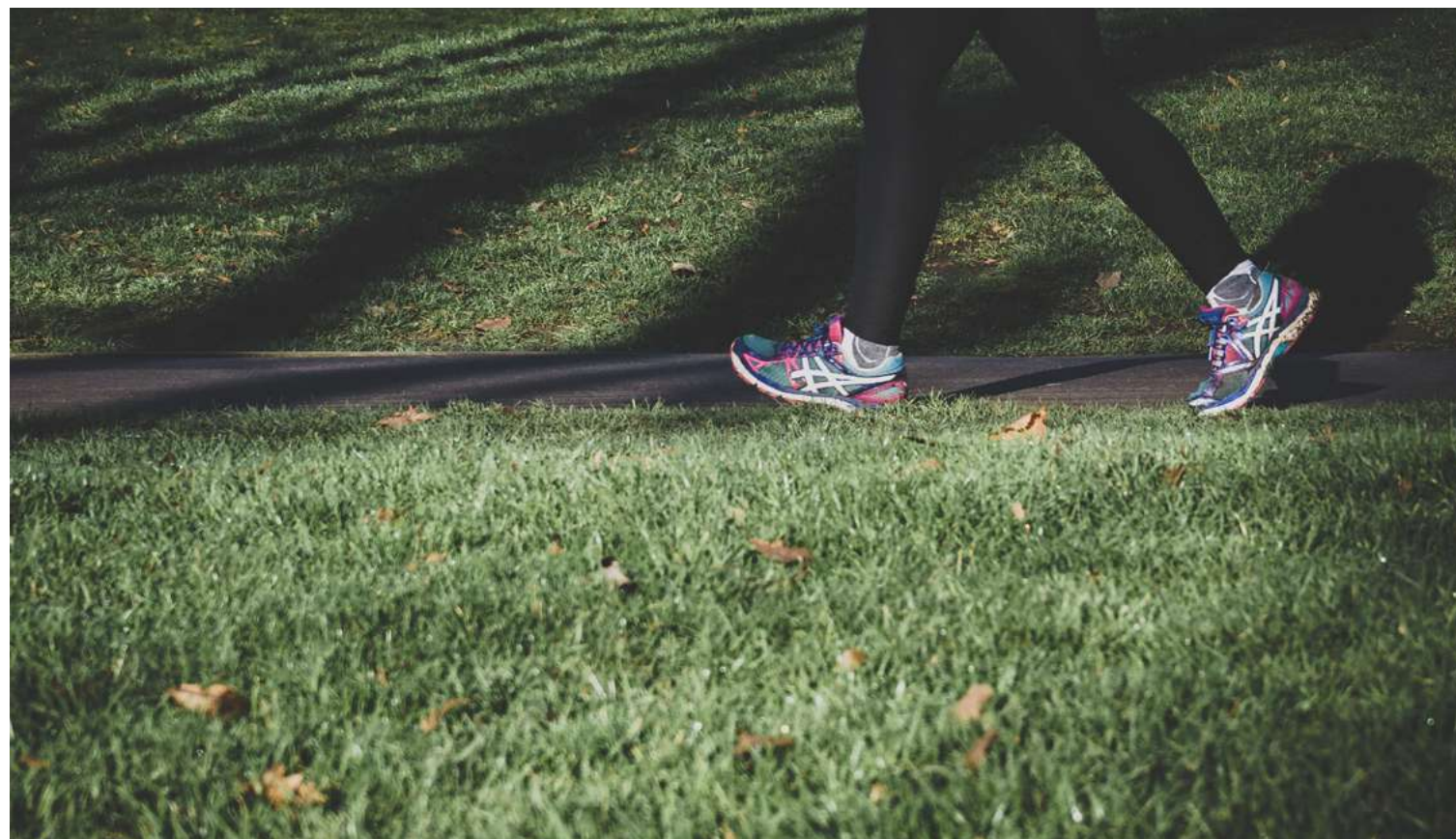

2. EDUCATION

For their personal and professional growth



3. COMPANY IDENTITY

For our identity and strength as a team



1. HEALTH



HEALTHCARE INSURANCE

Partnership with Metasalute Service to offer our collaborators supplementary health services to the National Health Service.

ERGONOMICS & SAFETY

We share **Safety Cross Reports** to supervise accidents at work and share safety guidelines within the company.

We take serious interest in our team's working conditions according to safety and ergonomics guidelines to ensure their safety and health while they carry out their daily activities.

SAFETY DAY

A training day organised as a "speed date" in which our team is invited to participate in 4 different workshops on the subject of Health, Communication and Safety at work.

2. EDUCATION (FOR OUR TEAM)



WELCOME PROGRAM

To greet and welcome new collaborators who have the opportunity to get to know our company, people and departments.

TRAINING CENTERS

All Rancilio Group collaborators are encouraged to expand their knowledge of our products and technologies. For this reason, we designed 2 spaces to help them during their training path:

RANCILIO TRAINING CENTER

Here our collaborators can learn more about Rancilio espresso machines and grinders.

EGRO TRAINING CENTER

For our collaborators to learn more about Egro fully automatic coffee machines.

COFFEE COMPETENCE TRAINING

During their welcome program, employees join our coffee competence training to learn more about the world of coffee and extraction techniques.

PROFESSIONAL TRAINING

Professional training is an exceptional opportunity for our team to expand their knowledge according to their professional needs. This includes the participation to English language and IT courses, professional education and master courses.

ESPRESSO ITALIANO TASTING CERTIFICATION (IIAC)

Our employees have the chance to learn about espresso coffee and tasting techniques. At the end of this course they can take the exam to become official espresso coffee tasters.



1471H

OF COMPLETED TRAINING COURSES
FROM SEP 2023 TO AUG 2024

40

NUMBER OF COURSES

273

ATTENDEES

2. EDUCATION (FOR TECHNICIANS)

153

TRAINING COURSES

684

TRAINED TECHNICIANS

8266H

TRAINING HOURS PROVIDED



WEBINAR

47

TRAINING COURSES

145

TRAINED TECHNICIANS

580H

OF TRAINING PROVIDED

ON-SITE

62

TRAINING COURSES

406

TRAINED TECHNICIANS

6090H

OF TRAINING PROVIDED

OFF-SITE

44

TRAINING COURSES

133

TRAINED TECHNICIANS

1596H

OF TRAINING PROVIDED

2. EDUCATION (OFFICINA RANCILIO 1926)

In collaboration with the Rancilio's family, Officina Rancilio – the official company museum – is a cultural space to discover Rancilio's entrepreneurial and family history.

Selected as part of Museimpresa, today it is used to promote cultural activities on the territory. In particular, the museum offers an educational project consisting of several free workshops designed for schools of all levels.

Officina Rancilio also represents a unique opportunity to transmit the company's "know-how" and our company's values.



2. EDUCATION (PARTNERSHIPS)

Rancilio Group is committed to continuous research and improvement for our people, products and processes.

For this reason, we join forces with a selection of Institutions to promote quality, education and research in the coffee industry.

- Istituto Espresso Italiano (IEI)
- Specialty Coffee Association (SCA)
- Politecnico Milano 1863
- Officina Rancilio 1926
- Confindustria
- ANIMA Confindustria Meccanica Varia
- Confindustria Alto Milanese
- HKI
- Assofoodtec

3. COMPANY IDENTITY

To increase the feeling of community and sharing within our company and among all the members of our international team.



RANCILIO DAY

We organize teambuilding activities to encourage socialization and mutual knowledge with a view to strengthening our teams.

RANCILIO GROUP GLOBAL SUMMIT

Annual meeting with Rancilio Group Representatives from all our branches to share ideas, developments and technologies.

OPENING SEASON SESSION

At the beginning of every financial year, we organise a meeting for our department managers outside our company borders in order to share budget reviews and align with corporate strategy.



COMPANY CANTEEN

It is characterised by friendly service and a varied menu based on simple and seasonal ingredients. It is an excellent opportunity to encourage socialising among our staff, and it can also be helpful for people living far away from the headquarters at Villastanza di Parabiago.

NOI PORTAL

A company portal for our Rancilio Group collaborators to share news, latest updates about the coffee industry and company resources.



3. GOVERNANCE

PERFECTING THE SYSTEM

Developing new company policies and guidelines which can help us implement sustainability across all levels of our business has become one main priority in our daily company strategy. We believe in the principle of continuous improvement, examining the efforts made throughout the years and imagining new paths to enrich our future. From the development of cutting-edge technologies to the selection of our supply chain, from the achievement of high quality standards to the strengthening of the relations with our stakeholders, we do our best to improve our processes and ensure our accountability.

KAIZEN APPROACH (CONTINUOUS IMPROVEMENT)

The Japanese word **Kaizen** (改善) is the composition of **KAI** (change, improvement) and **ZEN** (good, better) and means to change for the better, continuous improvement.

More precisely, Kaizen means slow and continuous improvement in personal, family, social and working life. When applied to the workplace, KAIZEN means continual improvement by involving everyone within the company - managers and operators alike.

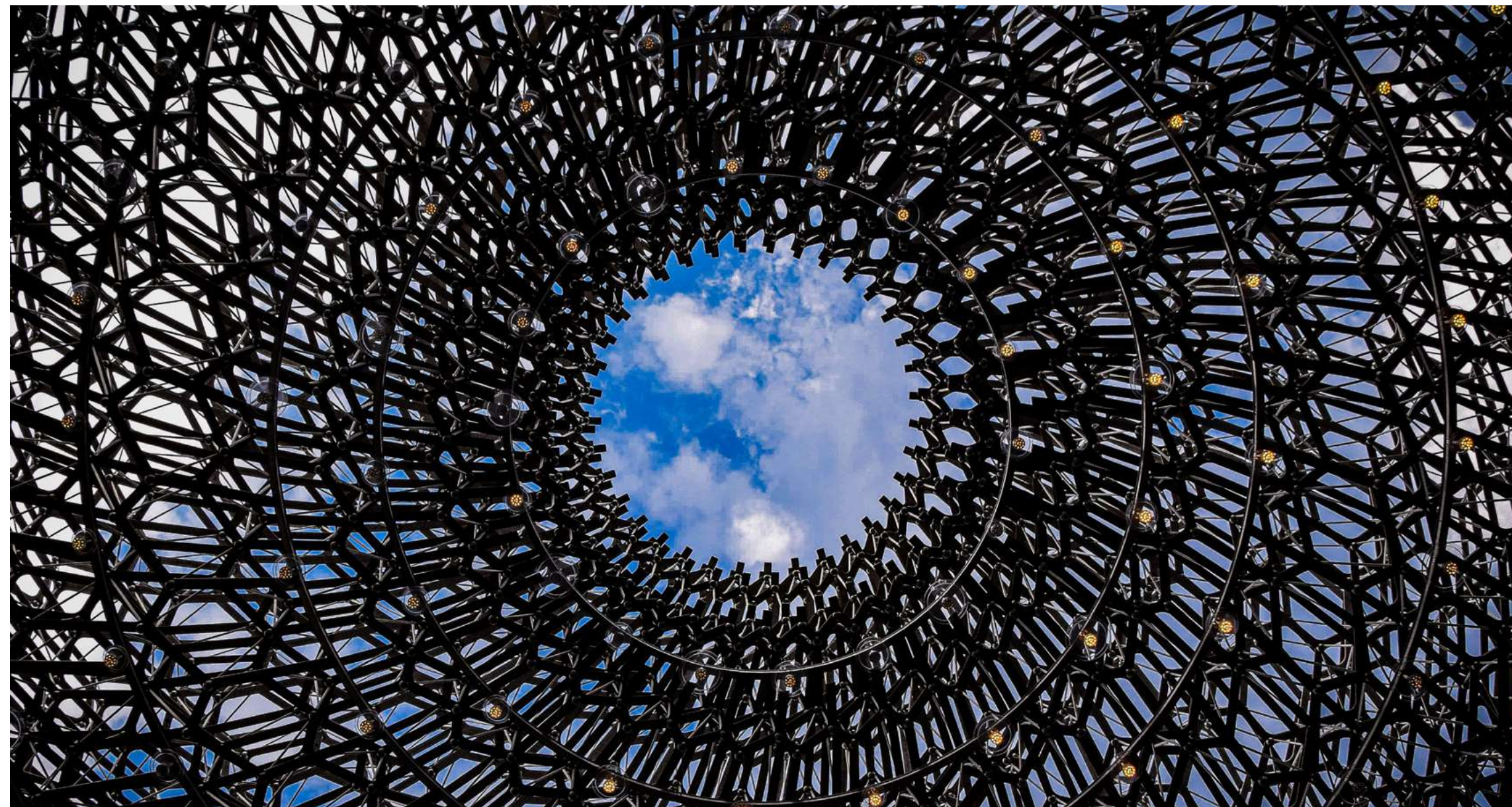

**KAIZEN APPROACH
(THE INSPIRING PRINCIPLES)**

CREATING CUSTOMER VALUE

TARGETING ZERO WASTE

FOLLOW THE ACTION

EMPOWER YOUR PEOPLE

BE TRANSPARENT

KAIZEN APPROACH (IN PRACTICE)

- Our production chain is based on an 80% assembly lines **interchangeability** and a **multi-mix** production system.
- Use of the **SUPERMARKET** model at the beginning of the lines to reorganize stocks and reduce waste.
- Reduction of order fulfillment time, superfluous stock, process congestion and increased response among departments.
- **Obeya Room** - Weekly meeting that brings together the managers of purchasing, planning, technical department, quality, marketing and all production channels.



LIFE CYCLE ASSESSMENT

Life Cycle Assessment (LCA) is a quantitative methodology regulated by the **international standards** ISO 14040: 2006 and 14044: 2006.

An LCA study identifies and measures the environmental impact related to the manufacture of a product following a **cradle-to-grave** approach, which considers all the phases of a product life cycle – from the selection of raw materials to the finished product, packaged and ready for shipment, to its disposal and recycle.



THE CARBON FOOTPRINT OF A COFFEE MACHINE

The objective of the study is the analysis of the carbon footprint generated by the production of coffee machines to identify critical issues in terms of environmental impacts and support future improvement strategies.

The analyzed process is modeled in a specific software that returns the results in terms of **impact indicators**.

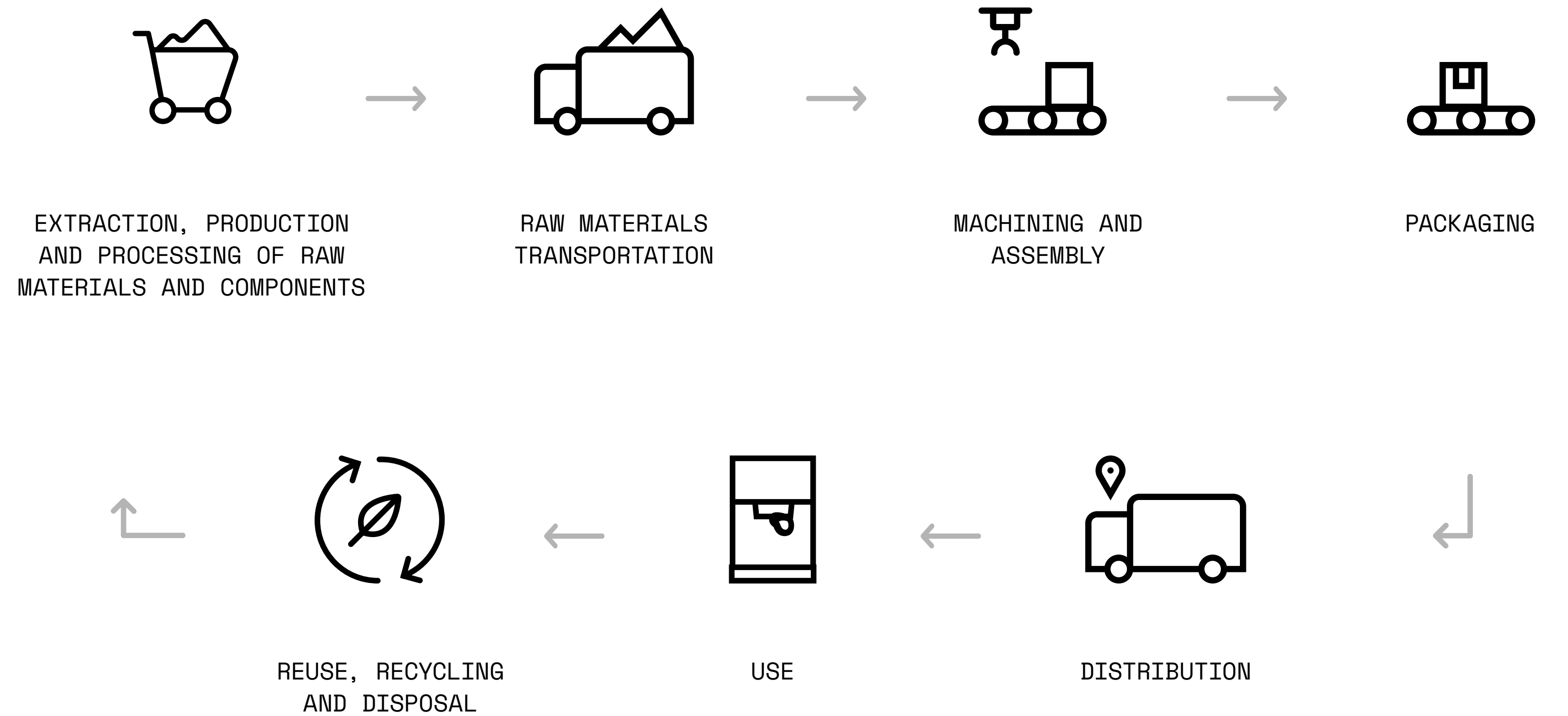

CLASSE 5 LCA STUDY

YEAR

2023

SUBJECT OF THE STUDY

CLASSE 5 USB with two brewing groups

APPROACH

"from cradle to grave"



PHASES UNDER ANALYSIS

1. Upstream
2. Core
3. Downstream

CLASSE 5 LCA STUDY (UPSTREAM PHASE)

Among the activities included in the Upstream phase, the extraction and production of materials is responsible for 94.61% of emissions.

Within this phase, the most relevant activity is the production of the components of the **electrical and electronic unit** of the machine whose impact constitutes **77.21%** of the CFP generated during the upstream phase.



CLASSE 5 LCA STUDY (CORE PHASE)

The impact of the **Core phase**, which includes production consumption, air emissions, external services and waste generated, constitutes **only 0.04% of the total** considered.

The **Production Phase** (Upstream + Core) causes the release of **1.51%** of total emissions.



CLASSE 5 LCA STUDY (DOWNSTREAM PHASE)

The downstream phase is responsible for **98.49%** of the overall environmental impact, considering the estimated energy and food consumption for the operation of Classe 5 over a period of **8 years**.

Food products, such as coffee, significantly contribute to the environmental impact due to **land use** (GHG land use) and **biogenic carbon** emissions (GHG biogenic), factors that explain the high percentages in the downstream category.

The results highlight the need for a **parallel analysis** of the production and usage phases to identify opportunities for improvement.

CLASSE 5 LCA STUDY (OBSERVATIONS)

We are committed to improving the energy efficiency of our machines and working with suppliers and consumers to reduce our overall impact, contributing to a more sustainable future for all.

SUPPLIERS EVALUATION

SUPPLY CHAIN EVALUATION

We select and rank our suppliers in terms of compliance with our values of quality, safety and environmental compliance to ISO 14001 and ISO 45001.

ENVIRONMENTAL LABELLING

Rancilio Group chooses to select packaging suppliers that comply with European environmental impact regulations to facilitate packaging collection, reuse, recovery and recycling.



PRODUCT QUALITY CERTIFICATIONS

SYSTEM

- ISO 9001 Management system certification
- ISO 45001 Occupational safety certification
- ISO 14001 Environmental management certification
- Ecovadis Bronze Medal

PRODUCT

- CE marking
- cETLus Listing Mark
- ETLus Listing Mark
- ETL Sanitation Mark
- Korea Certificate (KC)
- Regulatory Compliance Mark (RMC)
- InMetro
- EAC
- China Compulsory Certification (CCC)
- BSMI Certification
- Foodstuff Compatibility Declaration of Compliance
- Istituto Espresso Italiano (IEI)

TECHNOLOGIES (WE CRAFT INNOVATION)

Rancilio group has developed **3 technological hubs** to explore new coffee machine solutions, to develop new core technologies and to create cutting-edge products that can empower customers' business.

The strength of the Labs also lies in long-term partnership with suppliers, premium technologies partners, start-ups and universities.

We are committed to become one of the top R&D dept in coffee industry to always create new values through innovation and human talent.



TECHNOLOGIES (OUR LABS)

RANCILIO LAB

At Rancilio LAB we are always a step ahead. We design Rancilio espresso machines and grinders, developing cutting-edge brewing technologies. We are committed to always create new values through innovation and human talent.

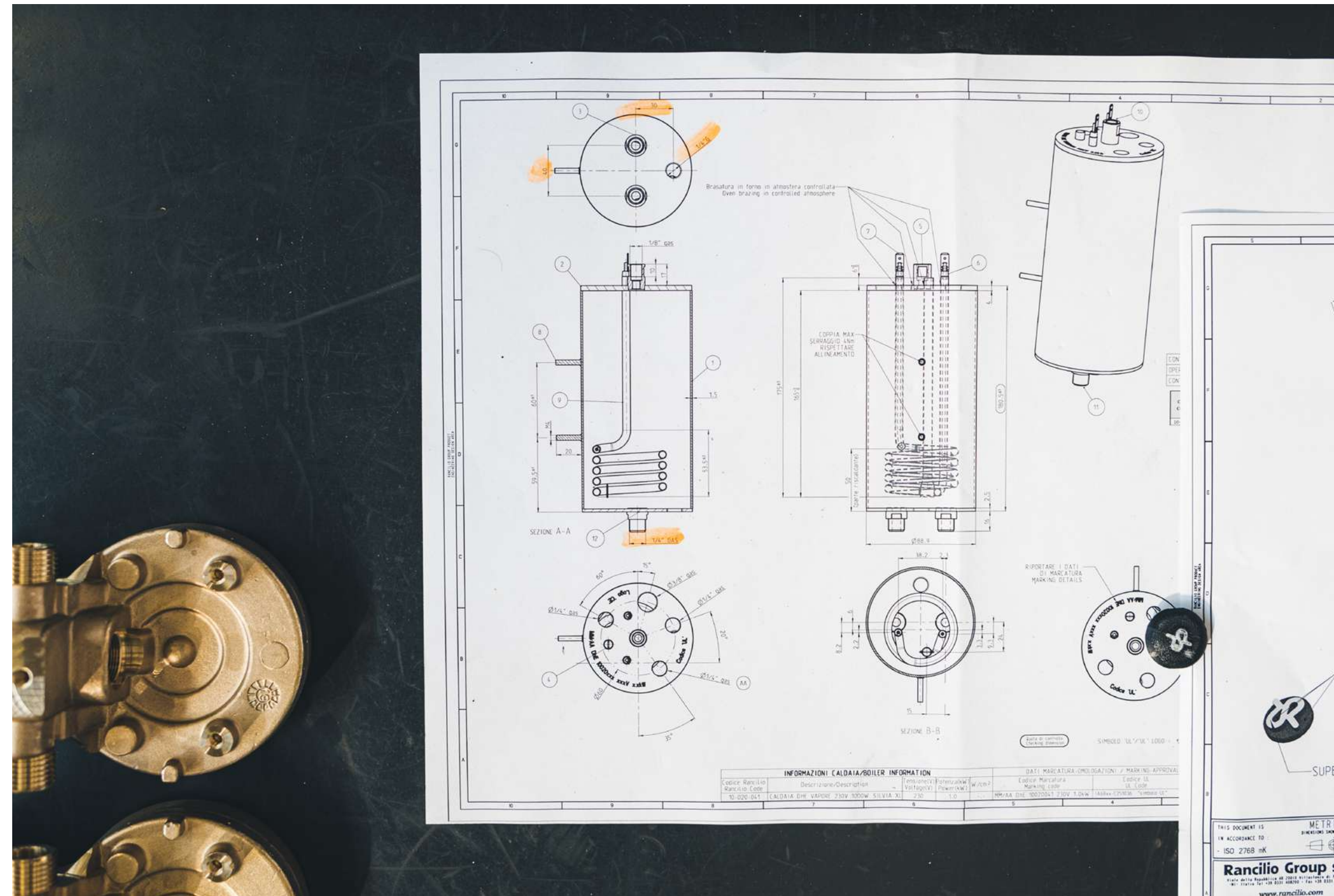

TECHNOLOGIES (OUR LABS)

EGRO LAB

At Egro LAB we design Egro fully automatic coffee machines, finding new ways of doing things. We develop every new products combining Egro long-standing expertise and new patented solutions, defining new standards in the coffee industry.

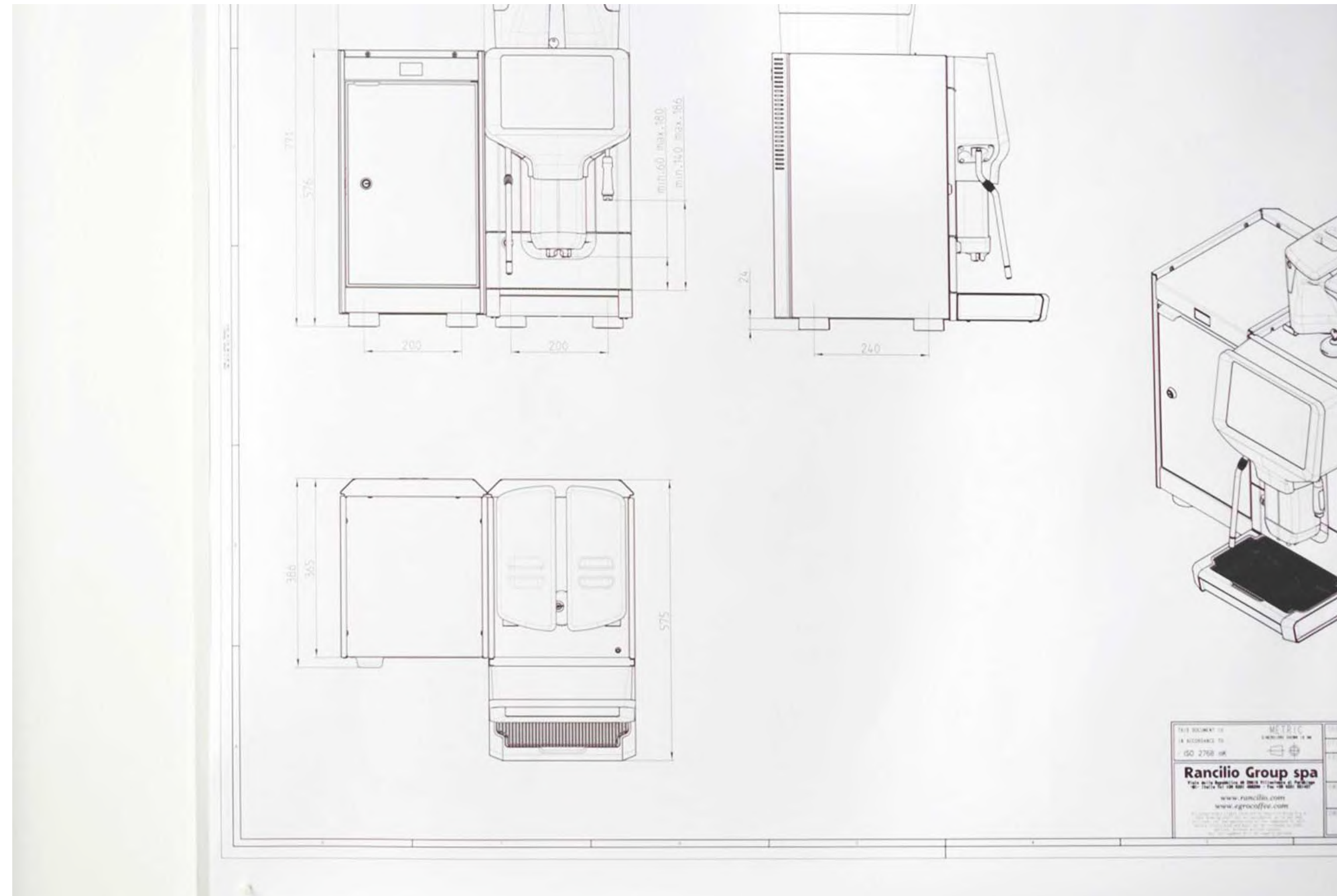

TECHNOLOGIES (OUR LABS)

EXTRACTION LAB

Extraction LAB is the scientific coffee laboratory led by the Rancilio Group Coffee Competence team that promotes research activities and organizes tasting sessions and workshops to examine different espresso coffee extractions exploring temperature profiling and other patented technologies.



DIGITALIZATION



As part of our digital transformation, we introduced a series of tools to reduce waste inside our company with:

- Centralized, real-time, cloudbase company and customer information.
- Digital management of orders, invoices, general customers' information and technical assistance.
- Reduce the use and printing of paper based documentation.

In addition, all our product catalogues and documentation are available online for our customers to download and consult on their screens.

DIGITALIZATION (CONNECT)

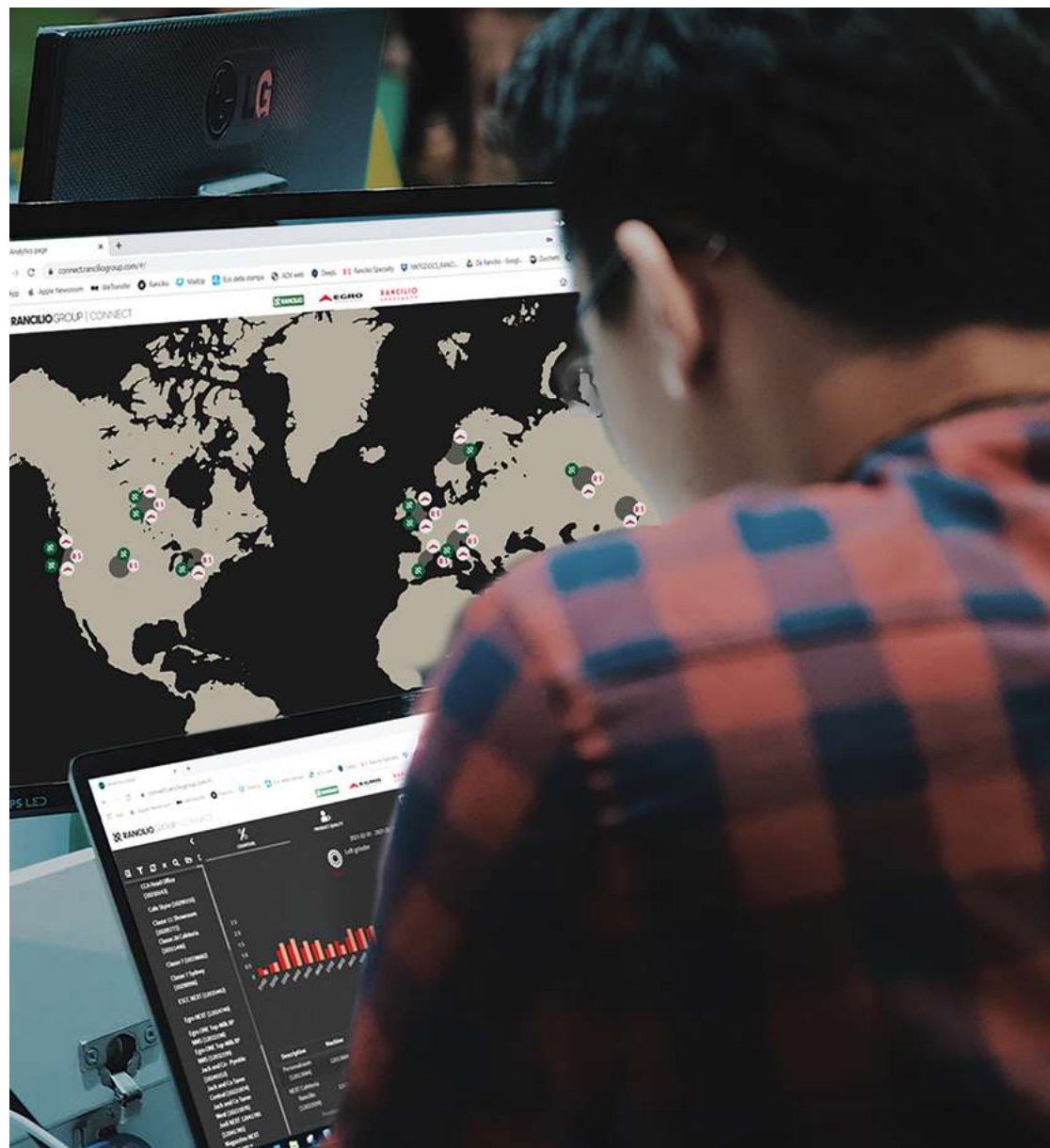

Connect is a powerful IoT solution developed by Rancilio Group to gather and easy analyze all the value-relevant data generated by a single coffee machine or an entire fleet from a remote workstation of your choice.

Via a customizable dashboard with widgets, tables and graphs, Connect gives you the chance to remotely identify and predict customers' issues.

This means:

- **Reducing unnecessary on-site interventions** considerably by a quick phone fix or by programming all interventions in an area in advance.
- **Extending product lifetime** by setting predictive maintenance.
- Cutting service and travel costs, saving time and especially resources by **optimizing your service routes**.

[WATCH OUR VIDEO](#)

**DON'T MISS OUR
UPDATES**

You can learn more about our contributions to sustainability on our website:

ranciliogroup.com/sustainability/

